



## Bhoruka Extrusions Pvt Ltd.

**“Our vision is to be the extruder of choice for iconic projects by delivering products and services that reduce our customers' total cost of ownership. We do this through innovative technology and a commitment to sustainability, customer satisfaction, and operational excellence”**

Established in 1979

100% subsidiary of \$8 Billion YKK AP Inc. Japan

Extrusion capacity of 1200 MT / Month (6"/ 8"/ 9" - extrusion press)

In-house Anodizing capacity of 250 MT / Month (Italtechno, Italy)

In-house Powder coating capacity of 350 MT / Month (Nordson , U.S.)

In-house Machining Facility with new CNC Machining Centres from FOM Industries, Italy

Approved PE-F/D-1036 and PE-SDF/D-2525 Applicator

Award winning SAP implementation ( ECC 6.0)

Approved extruder of systems – Airclos, Alu-K, Asahi, Dorma, EFP, IWIN-S, Lixil, Reynaers, Schueco

Online self-updating E-catalogue ( [www.bhorukaecatalogue.com](http://www.bhorukaecatalogue.com))

Online order tracking through SAP (Bhoruka 360 CRM portal) and Planning ( E-Planner)

Branches: Bangalore, Chennai, Coimbatore, Delhi, Hyderabad, Mumbai, Mysore, Pune

Dedicated Enquiry teams - [enquiries@bhorukaextrusions.com](mailto:enquiries@bhorukaextrusions.com)

## YKK GROUP

### YKK CORPORATION

### YKK AP Inc.

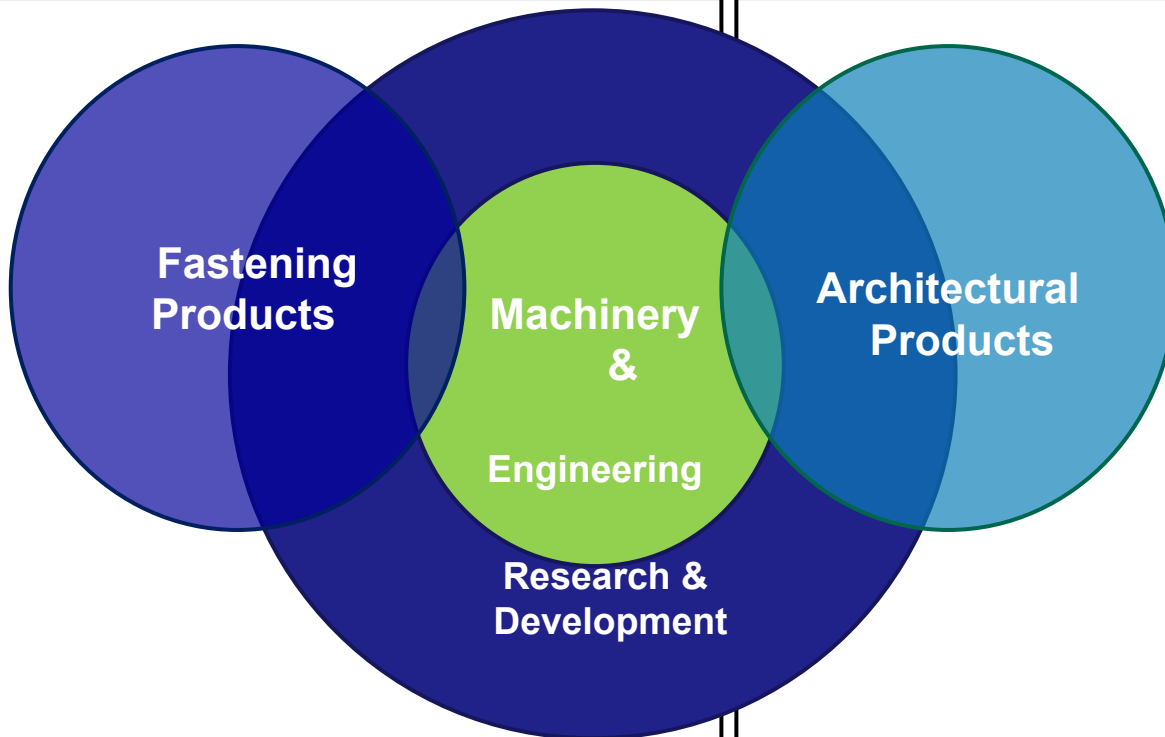

The YKK Group consists of YKK Corporation, the parent company, which produces fastening products, and YKK AP, which produces architectural products. At the center, we have the Machinery & Engineering Department, which supports research and development.

We build our own machinery to produce zippers, windows, and doors. These three business groups are the basis for global management.

## YKK CORPORATION

- **Founded** : January 1, 1934
- **Capital** : US\$121Million

## YKK AP Inc.

- **Founded**: July 22, 1957
- **Capital**: US\$101Million
- **Number of Employees** : 17,100

[As of Mar 2023]

## YKK GROUP

- **Description of Business**  
Fastening Products, Architectural Products, Manufacturing and Sales of Fastening and Architectural Machinery
- **Number of affiliated Companies**  
72 countries/regions worldwide.  
Japan: 18 Overseas: 90  
Total : 108 companies
- **Number of Employees**  
Japan : 17,891  
Overseas : 26,636  
**Total (Worldwide) : 44,527** (As of March 2023)
- **Sales** (Consolidated Basis) (Fiscal Year 2022)  
Fastening : US\$2,725 Million  
Architectural Products : US\$3,642 Million

**Total Sales (Worldwide) :**  
**US\$6,396Million**

(US\$=139.64Yen)

# 「 CYCLE OF GOODNESS 」



Typeface: Tenshiyo / Pen name: 「Rituzann」  
(It is named after the Tateyama mountain range that I looked up to forever)



Founding president Tadao Yoshida

“No one prospers unless they render benefit to others”

“If we keep creating **new values by innovative ideas** and **inventions** through our business activity, we can expand our business. That brings **prosperity to our customers** and business partners, and as a result, we can **make a contribution to society**”

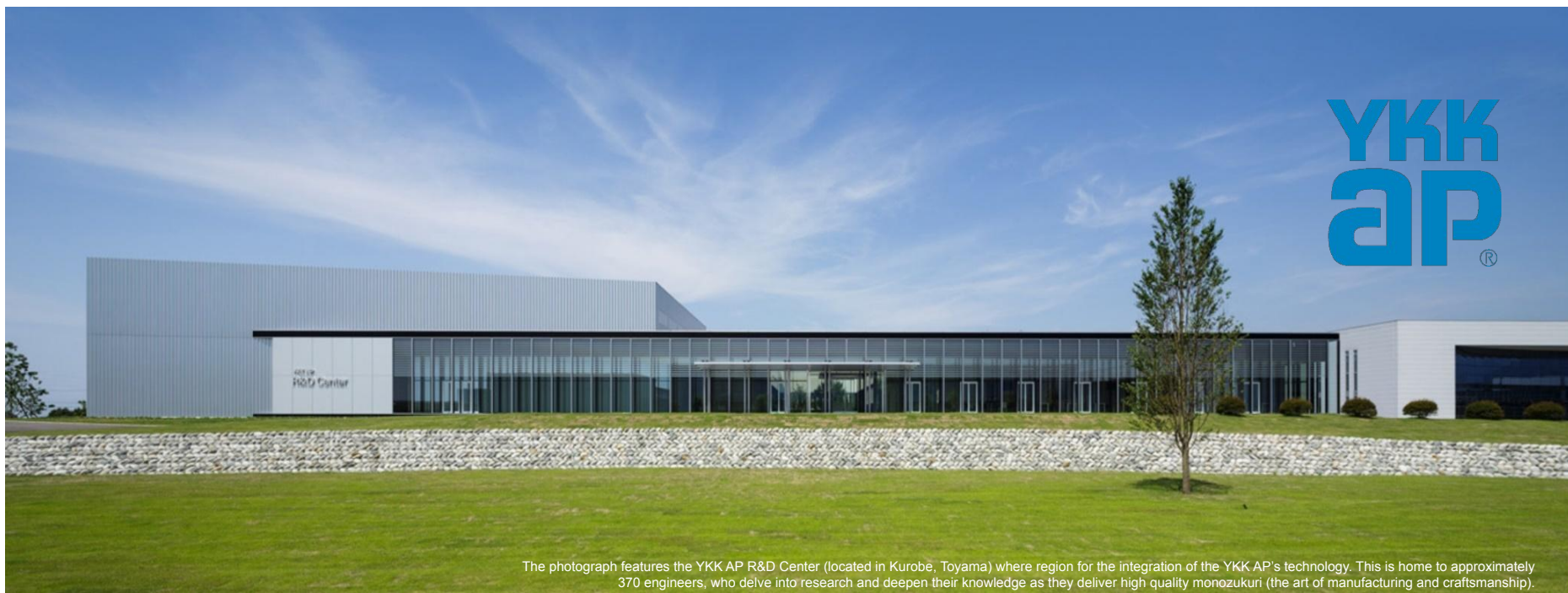

The photograph features the YKK AP R&D Center (located in Kurobe, Toyama) where region for the integration of the YKK AP's technology. This is home to approximately 370 engineers, who delve into research and deepen their knowledge as they deliver high quality monozukuri (the art of manufacturing and craftsmanship).

### Residential Business

<Main Products>  
Windows  
Entrance Doors and Sliding doors  
Interior doors and partitions  
Window shutters

### Exterior Business

<Main Products>  
Balconies  
Carports  
Gates and fences  
Terraces  
Exterior materials

### Renovation Business

<Main Products>  
Window remodeling  
Door remodeling  
Building renovation  
Quake-resistance retrofitting

### Commercial Product Business

<Main Products>  
Office Building Windows  
Curtain Walls  
Windows and doors for low- and medium-rise residential buildings  
Remodeling products

### Facade Business

<Line of business>  
High-rise and complex curtainwalls  
Design, construction and sales of related products

### Industrial Products Business

<Main Products>  
Components of machinery and equipment  
Auto parts  
Architectural components  
Eco-friendly products

Offices and centers in Japan

---

**201**

Manufacturing bases in Japan

---

**24**

Employees in Japan

---

**12,800**

Global HQ countries/regions

---

**11**

Overseas manufacturing bases

---

**8**

Employees overseas

---

**4,300**

## Advanced into Overseas Market since 1976 Building Local Business (10 Countries / Regions 15 Bases)

### Dalian YKK AP Co., Ltd. (1999)

Headquarters: Dalian  
Manufacturing Center: Dalian

### YKK AP (Suzhou) Co., Ltd. (2002)

Headquarters: Suzhou  
Manufacturing Center: Suzhou

### YKK AP Co., Ltd. (2001)

Headquarters: Shanghai

### YKK AP (China) Investment Co., Ltd. (2002)

Headquarters: Shanghai  
Manufacturing Center: Shenzhen

### Bhoruka Extrusion Pvt. Ltd. (2013)

Headquarters: Mysore  
Manufacturing Center: Mysore

### YKK AP MYS Sdn. Bhd (2011)

Headquarters: Kuala Lumpur

### YKK AP Taiwan Co., Ltd. (1989)

Headquarters: Taipei  
Manufacturing Center: Yangmei

### YKK AP HONG KONG Ltd.

Headquarters: Hong Kong

### YKK AP Facade Vietnam Co., Ltd. (2013)

Headquarters: Ho Chi Minh

### PT YKK AP INDONESIA

The Resident Representative Office in Vietnam (2012)

### YKK AP (THAILAND) CO., LTD (2015)

Headquarters: Bangkok

### YKK AP Singapore Pte Ltd. (1976)

Headquarters: Singapore

### YKK AP Facade Pte Ltd. (2008)

Headquarters: Singapore

### PT YKK AP INDONESIA (1986)

Headquarters: Tangerang  
Manufacturing Center: Tangerang

### Erie Architectural Products Inc. (2019)

Headquarters: Ontario(Canada)

### YKK AP America Inc. (1991)

### YKK AP Technologies

Headquarters: Atlanta  
Manufacturing Center:  
•Commercial- Dublin,  
Dallas,  
Cincinnati  
•Residential- Macon

● Headquarters & Manufacturing Center

● Headquarters

● Manufacturing Center

● Representative Office

※As of June 2020

## Grand Concept

YKK AP presents operational excellence built up around the world combining research and development through detailed study of the climate and characteristics of each region, to conceptualize new ideas creating comfortable environment for the people residing.



## Product Characteristics



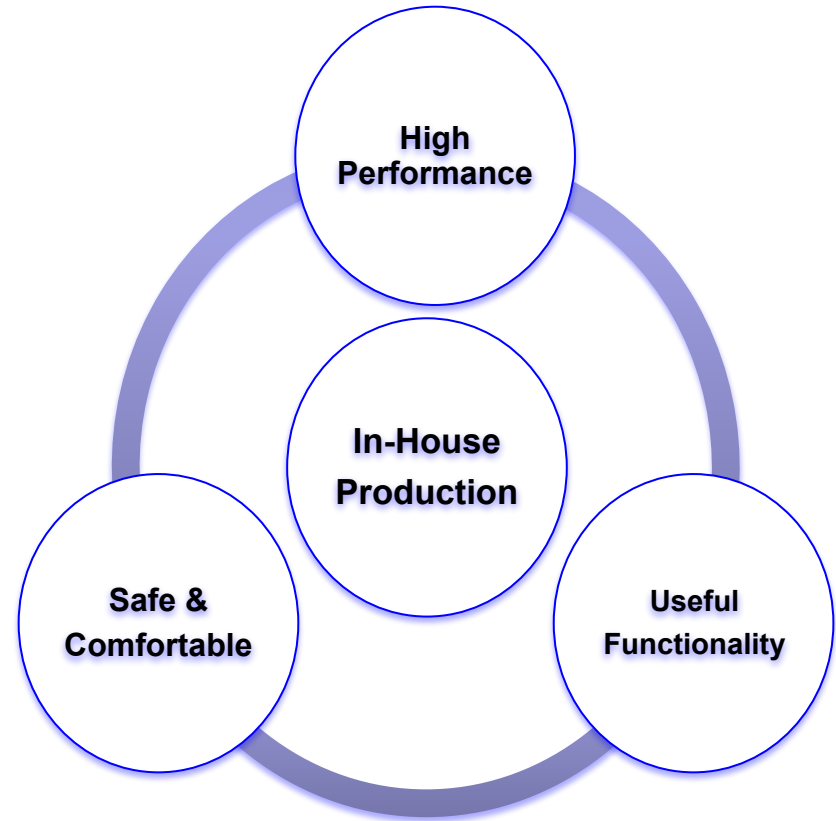

### Quality with a Difference

Setting Standards of Residential Fenestration Quality in India





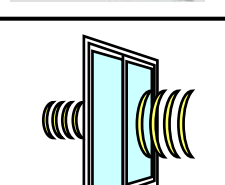
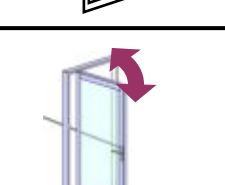







## □ Performance

Structural (Wind Load)		2500 Pa Deflection: 1/175 [ASTM E 330]
Air Infiltration		1.12m <sup>3</sup> / (h·m <sup>2</sup> ) Maximum at 75 Pa [ASTM E 283]
Water Tightness		600 Pa [ASTM E 331·547]
Sound Insulation		GradeT-2 [30dB] [JIS A 1416]
Open-Close Testing		30,000 Cycle No Damage [JIS A 4706]

Tested System with Basic Performance  
Safety and operation measures are considered  
to create a comfortable living environment

## □ Product Line Up

Sliding	Fixed / Casement Door
Sliding 2 LEAF (2 Track) 	Fix 
Sliding 4 LEAF (2 Track) 	Top Hung 
Sliding 3 LEAF (3 Track) 	Casement  
Sliding 6 LEAF (3 Track) 	Door  



# Organization Chart

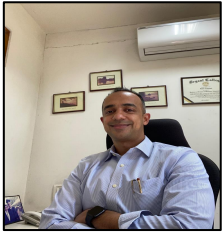

**Mr. Rajat Agarwal**  
Managing Director

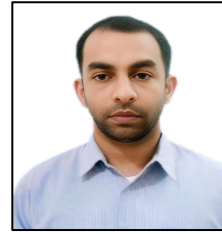

**Mr. Abhishek K**  
Extrusion



**Mr. Hamagishi Kodai**  
Technical Director



**Mr. Prashanth C**  
Surface Coating



**Mr. Kumagai Kaoru**  
Executive Director



**Mr. Mohan H C**  
Quality



**Mr. Prasanna Venkatesh**  
Factory Manager



**Mr. Praveen M H**  
Accounts and Finance



**Ms. Suma S**  
Planning



**Mr. Pradeep Rajshekar**  
HR

Billet Casting

Die Manufacturing

Extrusion

Anodising

Powder Coating

Machining

Components

TECHNICAL FACT SHEET			
Parameters	Press-1	Press-2	Press-3
MAKE	Wean United (USA)	Year Chang (Taiwan)	Cheng Hua (Taiwan)
Strength of extrusion press (TONS)	1800	1100	2750
Diameter of billet	203 mm	152 mm	228mm & 203mm
Diameter of container	210 mm	158 mm	236mm & 210mm
Diameter of main Cylinder - Inches	37	29.5	44.48
Diameter of small Cylinder - Inches	9	7.087	9.09
Maximum pressure of Press (BAR)	210 BAR	210 BAR	230 BAR
Mark of Billets	6063, 6005, 6105, 6061		6063, 6060, 6101, 6005, 6351, 6061, 6082
(6063-6060)			
Conveyor Length	36Mtrs.	36Mtrs.	50.90 Mts
Type of Billet Oven (gas, diesel, induction)	Hot log shear	Induction	Hot log shear
Type of Puller	Track type	Track type	Track type

TOOL ROOM	
Die types	Solid, Hollow, Semi-hollow
Dia CCD	Solid – 254mm; Hollow-230mm
# of sections	>14,000
Lead Time	Solid - 15 days; Hollow - 21 days

BHORUKA ANODISING	
Make	Italteco, Italy
Microns	5 to 25
Colors	Silver, Champagne, Bronze , Black
Maximum Length	6400 mm
Finish	Matt, Brush

BHORUKA POWDER COATING	
Pre - Treatment	Chemetall, Germany
Powder Coating	Nordson , U.S.
Spray System	Automatic
Thickness Range	60 To 120 Microns
Colors	All RAL Shades
Type	Metallic / Non Metallic
Gloss	High Glossy, Semi Glossy, Matt
Finish	Plain, Texture, Structure
Max Length	7500 mm

MACHINING	
Machining Centres	FMC 340, Blitz Alva-550 Double Head Cutting
Make	FOM Industries, Italy
Operations	Milling, Drilling, Boring, Countersinking, Angle Cutting, Turning & Tapping

## Chemical Composition as Per EN 573-3:2007

Alloy	Si	Fe	Cu	Mn	Mg	Cr	Zn	Ti	Aluminium Min
6063	0.20-0.60	0.35	0.1	0.1	0.45-0.90	0.1	0.1	0.1	Remainder
6060	0.30-0.60	0.10-0.30	0.1	0.1	0.35-0.60	0.05	0.15	0.1	Remainder
6061	0.4-0.8	0.7	0.15-0.4	0.15	0.8-1.2	0.04-0.35	0.25	0.15	Remainder
6005	0.6-0.90	0.35	0.1	0.1	0.40-0.60	0.1	0.1	0.1	Remainder
6105	0.6-1.0	0.35	0.1	0.15	0.45-0.8	0.1	0.1	0.1	Remainder
6082	0.7-1.3	0.5	0.1	0.4-1.0	0.6-1.2	0.25	0.2	0.1	Remainder
6101	0.30-0.7	0.5	0.1	0.03	0.35-0.8	0.03	0.1	0	Remainder
6351	0.7-1.3	0.5	0.1	0.40-0.8	0.40-0.8	0	0.2	0.2	Remainder

## Mechanical properties as per DIN 755-2/IS-1285

Alloy/T6	Tensile Strength, <i>min</i> MPa	Proof Stress <i>min</i> MPa	Elongation A50mm <i>min</i> in %
6060	185	150	7
6101	200	170	8
6063	185	150	7
6005	255	200	15
6105	260	240	8
6061	290	235	7
6351	295	255	7
6082	295	255	7

## Tempers:

- T4-Solution heat treated & naturally aged
- T5-Cooled from hot working and artificially aged (at elevated temperature)
- T6-Solution heat-treated & naturally aged.

# Extrusion Range Guidelines

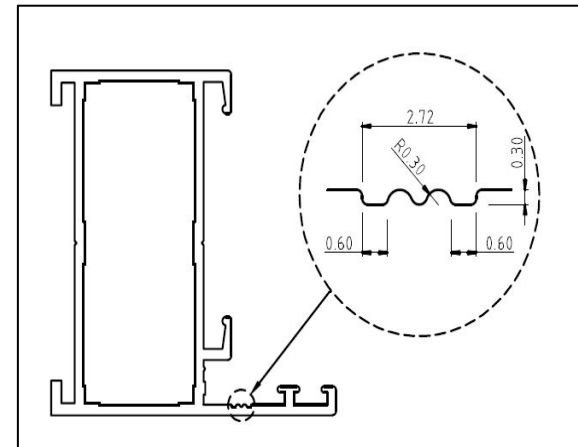
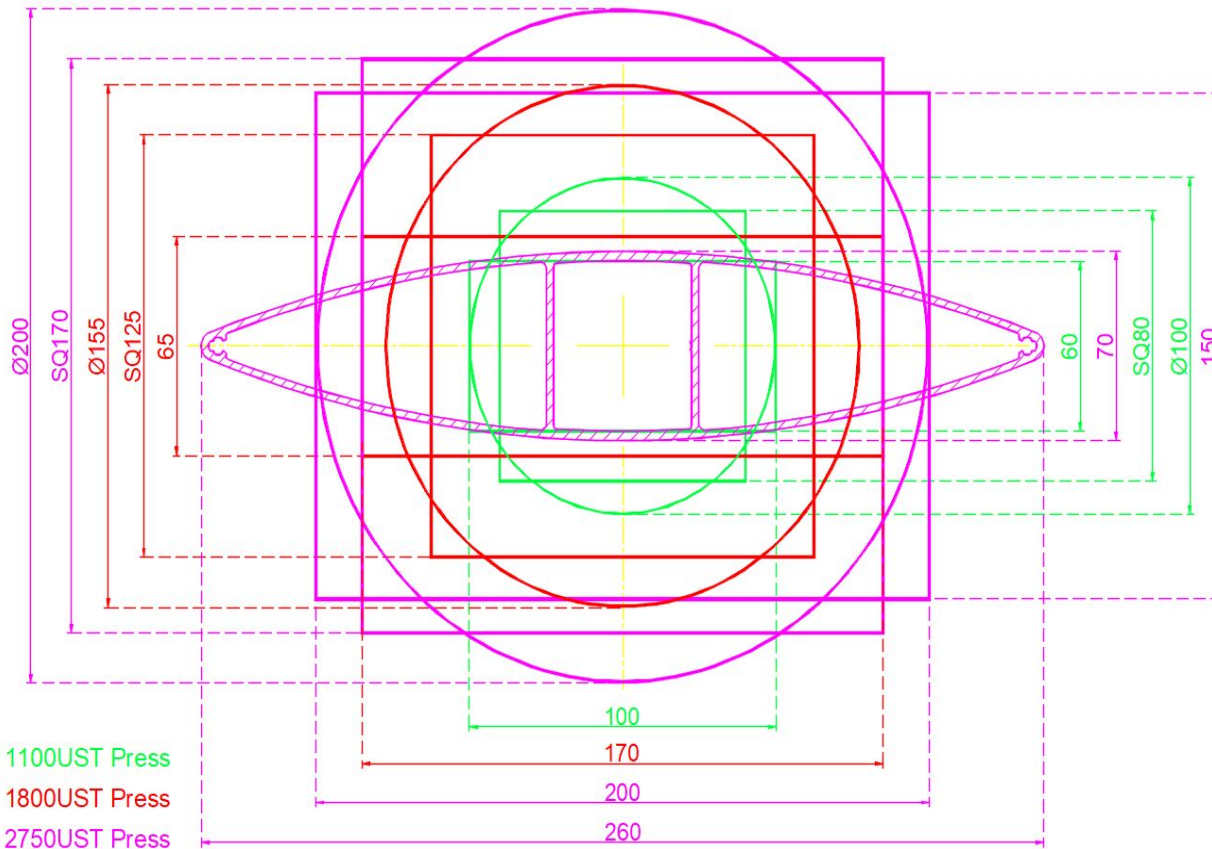

- Unique Identification mark in all new profile developments (since 2015)
- This Identification mark will be prominent throughout the profile length (utilizing only 0.3mm thickness)
- It will be located at only non-functional and unexposed/hidden area of the profile.
- ID mark will be non-functional/ un-exposed area)

8"--Press-1 (1800UST)	
Square	125x125mm
Rectangle	170x65mm
Circle	Ø155mm

9"--Press-3 (2750UST)	
Square	170x170mm
Rectangle	200x100mm
Circle	Ø200mm
Elliptical	260x70mm

6"--Press-2 (1100UST)	
Square	80x80mm
Rectangle	100x60mm
Circle	Ø100mm



- **Extrusion**



- **Billet Casting**



- **Die Tooling**



- **Anodizing**



- **Powder Coating**
- **Components**





- Percentage on complaints is at all-time low!  
Well below industry norms
- Rework percentage was very low and achieved the lowest plant rejection rate of 3.5 % last year
- Customer rejection is less than 0.27%

“No QC teams are needed, every process has QC inbuilt”

*Mr. Mohan H C*  
*Quality control*



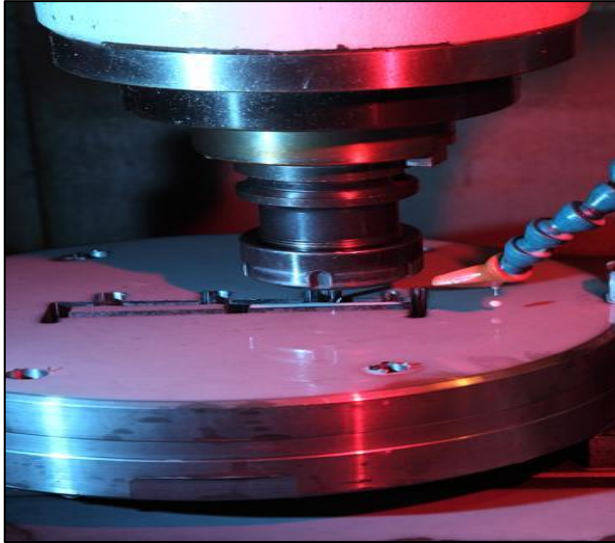

- With state of the art technology with latest machinery like CNC wire cutting, surface grinding etc, which helps improving die quality
- R&D is intrinsic to our process, we design exactly to your need
- We are consistently developing ~100 dies/month of which 75% are for new shapes



With our 3D-printing technology our customers can test the product for snap/slide fitment or gasket development prior to die manufacturing

- FFF printing technology with auto platform calibration.
- Print up a 60-micron resolution with a 0.25mm nozzle.

## Building and Construction

We are one of the **largest direct-sales suppliers** to **the building and construction sector** in India and offer various products ranging from Doors, Windows, Railings, Formwork, Shutters, Curtain Wall systems and more in a wide variety of shapes, sizes and finishes! Our value offerings can be broadly categorised as follows -

### Catalogue

Our catalogue contains more than 10,000 sections that Bhoruka has developed by virtue of being in the industry for more than 40 years. It offer a wide variety of readily available designs from various industries and sectors for you to choose from

### Made-to-order

Drawing from our vast experience, our Design and Engineering department excels at meeting specific customer requests as per the needs and demands of various projects and helps in turning your vision into reality

### Systems

We have the unique distinction of being the only extruder in India associated with many globally reputed systems such as Airclos, AluK, Dorma, EFP, Schueco to name a few. We will be delighted to offer their range of products through authorised channels

E-Catalogue Online self-updating catalogue with unique set of features

- Get instant access to thousands of profiles listed by different categories/sub-categories
- View product images & description along with other details
- Download drawings in PDF format right on your computer
- Send us an enquiry with complete details directly from the software
- Search by 'section number'
- More than 50 designs automatically added every month right on your computer
- Choose from our on-line as well as off-line module for on-the-go work



## OEM

Since our inception, Bhoruka has been catering to the growing demand and utilization of aluminum in various sectors ranging from – Electronics, Transportation, Textiles, Renewable Energy, Defense, Aerospace etc. We also specialize in the development of custom-made profiles under our made-to-order offering. We have extensive experience in working with various industrial alloys such as 1060, 6063, 6005, 6082, 6061. Some of the key sectors served by us are –

### Electrical & Electronics

One of the earliest uses of aluminum sections was in the Electrical & Electronics sector. Bhoruka has been supplying aluminium in this sector for over 30 years. Most of our sections are used for applications which require very good conduction, heat control, heat transfer etc. We manufacture a wide variety of sections using different alloys depending on the end-use of our customers

### Transportation

We have got a wide range of sections which are used in the Transportation Sector. Some of our product range includes sections for Bus Body & Truck Body. Bhoruka also manufactures sections for carriers, footsteps and other light SUV requirements

### Textile industry

We supply various sections for for the textile industry, which is an important part of the Indian economy. The quality & precision of these sections are of high importance & Bhoruka is committed in providing both the right quality & service to this sector

### Renewable Energy

Bhoruka has been always committed to a safer and better environment. Keeping this in mind we have dedicated offerings for our solar panel and windmill customers. These sections are often supplied in natural anodizing which are all done at our own in-house facility.

# Key Features of buying from Bhoruka

Factor	Bhoruka	Competitor	BEPL-Advantage
SO Release	Pieces	Kgs	Matches with FAB Cutting-list software
Weight Measurement	Drawing Mean Weight	Actual Weight	Matches with Tender weight, PO-Invoice consistency, ~3.5% savings on powder weight
Dispatch Tolerance	1-1000 pcs (-0%+5%)/ >1000 pcs (-0%+2%)	+/- 10% in Kgs	Reduced inventory and less total cost
Matching Section	@Aging and Invoice blocked	No check	Reduced inventory at customers
Order Status	Online	NA	Customer can track PO-Invoice online
Est Dt Dispatch	E-Planner (March 2019)	MS Excel	Customers can plan operations based on estimated date of dispatch

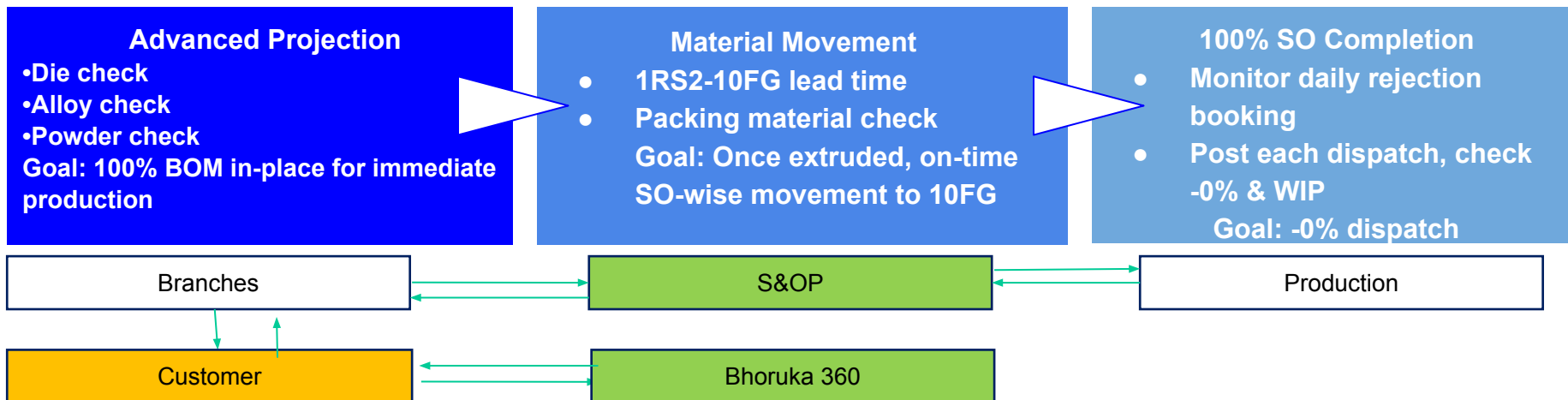

# Feature Comparison Table

Segment	Door & Window				Curtain Wall		
Product → Features ↓	Catalogue , Existing dies	IWIN-S	IWIN- E	BXW	Catalogu e, Existing dies	Customize Extrusions-Ne w Dies	True facade System
Tested Product	✘	✓	✓	✓	✘	✘	✓
System Design	✘	✓	✓	✓	✓	✘	✓
Product drawings	✘	✓	✓	✓	✘	✘	✓
Structural Calc	✘	✓	✓	✓	✘	✘	✓
Wind Load Test	✘	2.5 Kpa	1.6 Kpa	1.6 Kpa	✘	✘	✓
Water Test	✘	300-600Pa	100Pa	✘	✘	✘	✓
Profile	✓	✓	✓	✓	✓	✓	✓
P&A	✘	✓	✓	Euro Groove Compatible	✘	✘	✘
Coating: PC/ Anodizing	✓	✓	✓	✓	✓	✓	✓
FTS Support	✘	✓	✓	✓	✘	✘	✘
System Warranty	✘	✓	✓	✘	✘	✘	✘
Billing	KG Basis	Sqft. Basis	Sqft. Basis	Sqft. Basis	KG Basis	KG Basis	KG Basis
Glass	✘	✘	✘	✘	✘	✘	✘

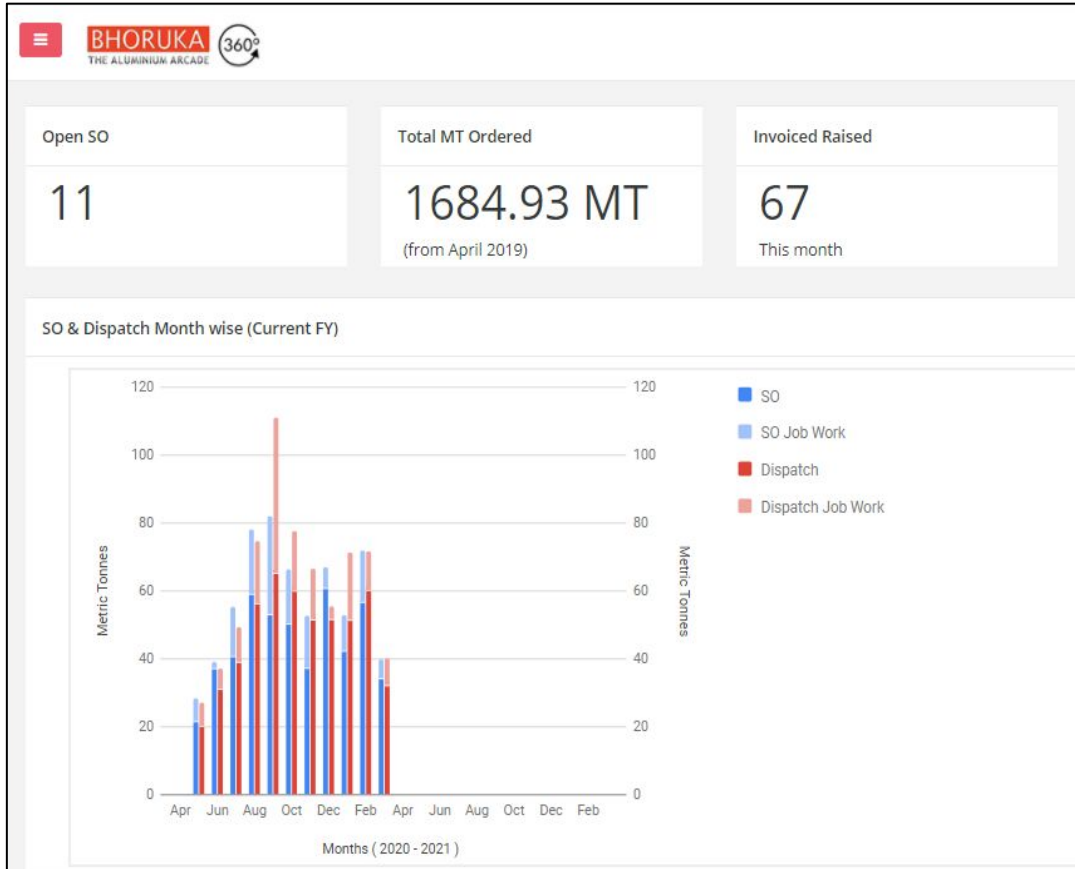

- Industry-first CRM Module Bhoruka 360 for customers (100% automated via SAP)
- Invoices, test certificate and packing list are readily available in the portal
- Live updates on your orders are made available
- Real-time order status and expected order completion dates
- PO Upload, PI Approval and Ticketing system to raise the Quality Complaints
- Financial Ledgers of Transactions executed with Bhoruka Extrusions are made available

“ Available multidimensional operational metrics gives me a 360° view ”

**BHORUKA 360°**  
THE ALUMINIUM ARCADE

INV # : 0094422632 Dated : 02 Mar 2021

SO #	:	Transporter Name	:	OTHER PARTY
PO #	:	Transporter LR #	:	
PO Date	:	Vehicle #	:	
Project Name	:	Driver Phone #	:	
Deliver #	:		:	
Text	:		:	

Uploaded Documents

1	Warranty certificate	
2	Test certificate	
3	Photos	
4	Packing List	



Mr. Mathew Shijoy



Ms. Suma S

## Interpon D1000



## InterponD2000



## Interpon D3000



## PE-F



## PE-SDF

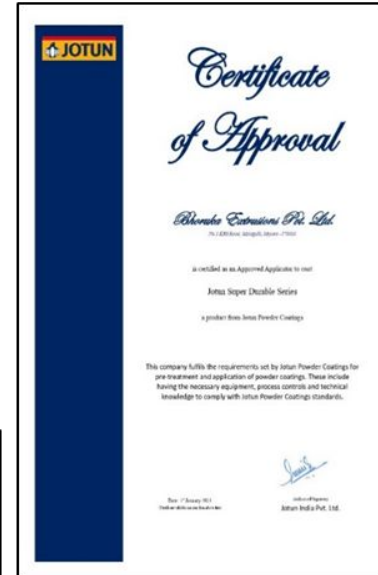

## ISO 9001:2015

Bureau Veritas Certification



**BHORUKA EXTRUSIONS PVT. LTD.**

**BHORUKA**  
A YKK AP COMPANY

NO. 1, KRS ROAD, METAGALLI, MYSURU – 570 016, KARNATAKA, INDIA.

*Bureau Veritas Certification Holding SAS – UK Branch certifies that the Management System of the above organisation has been audited and found to be in accordance with the requirements of the Management System Standard detailed below.*

---

*Standard*

**ISO 9001:2015**

*Scope of certification*

---

**MANUFACTURE OF MILL FINISH, ANODIZED AND POWDER COATED ALUMINIUM EXTRUSIONS IN STANDARD AND FUNCTIONAL SHAPES FOR STRUCTURAL / ARCHITECTURAL COMPONENTS, TRANSPORT, TEXTILE AND ELECTRICAL INDUSTRIES**

Original cycle start date: 12 March 1995  
 Recertification cycle start date: 09 December 2024  
 Subject to the continued satisfactory operation of the organisation's Management System, this certificate is valid until: 12 December 2027  
 Certificate No. **IND.24.2447/Q/MU** Version: 1 Issue date: 09 December 2024

For certificate authenticity, click here <https://isocheck.bv.com>

ISO 9001 | IND41568

Signed on behalf of BVCS UK Branch  
**Jagdish N. MANJAN**  
 Director – CERTIFICATION, South Asia  
 Commodities, Industry & Facilities Division

Certification body address: 5th Floor, 100 Lower Thames Street, London, EC3R 6EL, United Kingdom.

Local office: Bureau Veritas (India) Private Limited (Certification Business)  
 T2 Business Park, Main Industrial Area, MEDC Cross Road "C",  
 Andheri (East), Mumbai – 400 093, India.

Further clarifications regarding the scope of this certificate and the applicability of the management system requirements may be obtained by consulting the organisation at [cert@bv.com](mailto:cert@bv.com).  
 To check this certificate validity please call +91 22 6274 2999.



## IGBC



*Membership Certificate*

*This is to certify that*

**Bhoruka Extrusions Pvt Ltd**

*is an Annual Member of Indian Green Building Council (IGBC)*

*Bearing Membership No IGBCMM170151*

*This certificate shall be valid up to December 2025*

  
**K S Venkatagiri**  
 Executive Director  
 CII - IGBC

  
**B Thiagarajan**  
 Chairman  
 Indian Green Building Council

  
**C Shekar Reddy**  
 Vice Chairman  
 Indian Green Building Council

Indian Green Building Council  
 CII - Sobrahji Godrej Green Business Centre, Survey No. 64, Near Hitech City, R R Dist, Hyderabad - 500 084  
 T: +91 40 4418 5132 / 33 F: +91 40 4418 5189 E: [igbc@icli.in](mailto:igbc@icli.in) W: [igbc.in](http://igbc.in)

## GRIHA



**GRIHA Council**  
 This is to certify that the products of

**“Bhoruka Extrusions Private Limited”**

*IRWIN Range of Aluminium Doors and Windows*  
 (Under Typology: Doors & Windows: panels and frames)

have been included in the GRIHA Product Catalogue under the following categories:

**GRIHA V.2015 criterion: 21 & SVAGRIHA criterion: 12**  
 and  
**Aluminium extrusions**  
 (Under Typology: Innovation products)

has been included in the GRIHA Product Catalogue under the following categories:

**GRIHA V.2015 criterion: 31 & SVAGRIHA criterion: 14**

The products can be used in GRIHA & SVA GRIHA registered projects to meet the GRIHA & SVA GRIHA norms, respectively. This is valid only for the products which have been mentioned above.

The certificate for the above-mentioned products is valid from  
**24<sup>th</sup> May 2024 – 23<sup>rd</sup> May 2026**

  
**Sanjay Seth**  
 Vice President & Chief Executive Officer

Note:  
 1. Before selecting the above specified products, it is recommended to revalidate that the project is meeting the GRIHA's mandatory compliance.  
 2. This evaluation has been done based on the documentation – in the form of 3rd party test results and/or declarations – submitted by the manufacturer to GRIHA Council.  
 3. The certified product(s) only qualify for the criterion mentioned in the certificate.  
 GRIHA Council is a joint initiative of Ministry of Home and Parliamentary Affairs, Government of India and The Energy and Resources Institute (TERI) to implement GRIHA (Green Rating for Integrated Habitat Assessment), India's National Rating System for Sustainable Habitats. [www.grihaa.org](http://www.grihaa.org)

## FMC 340

- Make - FOM Industries, Italy.
- Fully automated processing center
- 4 Interpolating axes for the machining of aluminium profiles with a cross section of 180×270 mm and tubes up to 3 mm thick.
- Can perform operations such as Milling, Drilling, Countersinking, Angle Cutting, Turning & Tapping.



## BLITZ ALVA - 550

- Make - FOM Industries, Italy.
- A high-performance Double Head Cutting machine that is specifically designed for cutting operations.
- Equipped with advanced technology and features that allows for high precision and accuracy in cutting
- Maximum Cutting Capacity between 2 Heads- 6.6m

## Transport

- Metro coaches
- Gangway part

## Automotive

- Foot Step
- Roof Rails

## Textile

- Roving Tubes
- Bobbin Rail

## Projects

- Radiant Baffle
- Cycle frames



**Machining** – Inhouse machines from Emmegi, and Hurco

**Project Management** - Developing the entire value chain and taking responsibility upto end delivery

**Designing** – Working with customer to simplify their designs for efficiency and cost reduction

**Tools and Fixture Developments** – To improve storage and packaging specific to projects

**Special Purpose Machine (SPM)** - Developed bending , and turning machines inhouse

**Sub Assembly** – Steel, plastic, wooden and electronic sub assembly



#427E, Hebbal Industrial Area

Mysore – 570016

Karnataka, **India**

Phone- +91 - 821 - 2510351 / 2513876

E-mail: [marketing@bhorukafabcons.com](mailto:marketing@bhorukafabcons.com)

Web: [www.bhourkafabcons.com](http://www.bhourkafabcons.com)



# Government Clients





# Our Valued Customers



# BHORUKA

A YKK AP COMPANY

When you think extrusion, think **Bhoruka**, Your partner of choice

## Thank You